

FEIDER

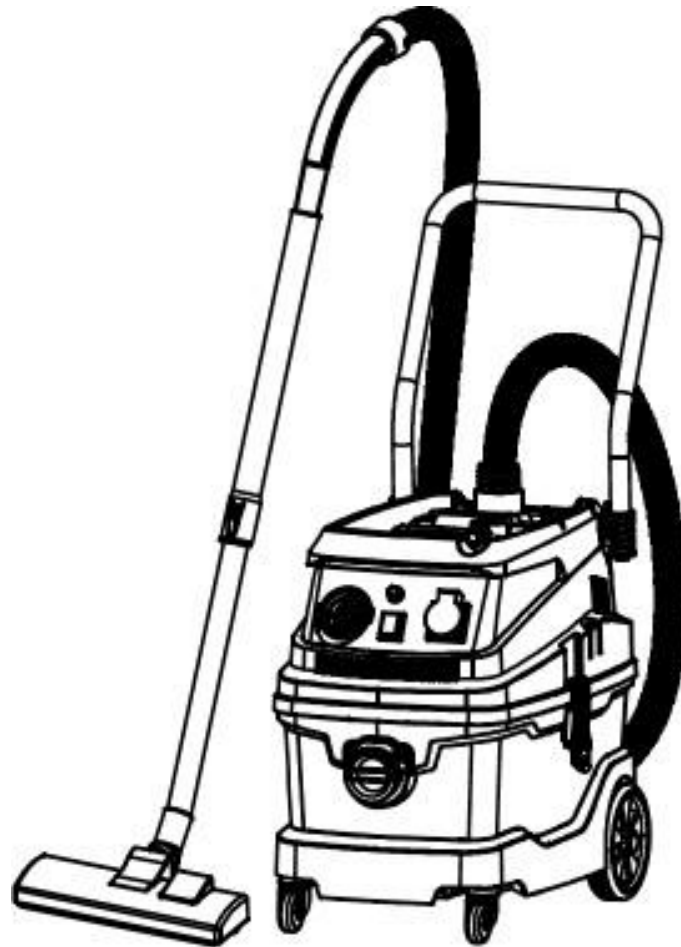

WATER AND DUST VACUUM CLEANER

FAP1630

USER GUIDE

CAUTION: Read this manual before using this machine!

CONTENTS

1. SAFETY INSTRUCTIONS.....	3
2. THE PRODUCT.....	6
3. OPERATION.....	7
4. MAINTENANCE.....	10
5. TROUBLESHOOTING.....	10
6. EXPLODED VIEW AND PARTS LISTS.....	11
7. DISPOSAL.....	13
8. DECLARATION OF CONFORMITY.....	14
9. WARRANTY.....	15
10. PRODUCT FAILURE.....	16
11. WARRANTY EXCLUSIONS.....	17

1. SAFETY INSTRUCTIONS

General safety instructions for machine preparation, operation and maintenance are provided in this manual. The use should comply with the instructions. Otherwise, in case of an accident, the manufacturer shall not be held responsible.

Considerations relating to safe use

1. Do not use in areas containing inflammable liquids or gases, or in areas protected against explosion, and protected against fire.
2. Turn the switch Off and unplug before cleaning or repairing to prevent fire hazard.
3. Be careful because the hose and body can be charged with static electricity.
4. Do not step on the hose, pull on the hose when it is rolled up; if the hose is damaged, do not use it again; do not place heavy or sharp objects on the hose; do not use a high-pressure cleaner.
5. Do not let the power cord get stuck in a door, or use the wire to pull the vacuum cleaner, protect the power cord.
6. Be careful of your own safety during use, keep away from suction or moving parts.
7. Do not place the entire machine in water, do not touch the plug with wet hands or a wet towel to avoid electric shock.
8. The supply voltage must correspond to that of the device, do not use it with a voltage different from the rated voltage of the device.

9. Before suctioning water, remove the dust bag, filters and use a sponge filter.

10. Clean the tank if it contains a lot of dust.

Warning

1. This appliance can be used by children aged from 8 years and above and persons with reduced physical, sensory or mental capabilities or lack of experience and knowledge if they have been given supervision or instruction concerning use of the appliance in a safe way and understand the hazards involved. Children shall not play with the appliance. Cleaning and user maintenance shall not be made by children without supervision.

2. If the supply cord is damaged, it must be replaced by the manufacturer, its service agent or similarly qualified persons in order to avoid a hazard.

3. The plug must be removed from the socket-outlet before cleaning or maintaining the appliance.

4. Do not suck glass, iron and other sharp debris into the hose and body as this may damage the hose, filters, etc.

5. Do not suck hot, flammable, caustic or explosive substances to avoid the risk of fire and electric shock.

6. The suction of hair, paper, cement, chalk, putty powder, sticky substances can easily block the vacuum cleaner, and this could cause a fire; sucking these substances is not advisable;

7. Do not use for an extended period of time when the

air inlet is blocked, otherwise it can damage the vacuum cleaner.

8. Stop when an abnormal sound is emitted; check and clean.

9. Do not let children play with the vacuum cleaner accessories to avoid accidents.

10. If the electrical power is high, use a separate electrical panel to prevent fire.

11. Remove the plug from the power outlet when the appliance is not in use; monitor the device when it is in use.

12. Do not place the vacuum cleaner or power cord close to any heat sources to avoid fire.

13. Do not use the power cord or power plug if one of them is damaged, a professional should perform repairs;

Product instructions

The vacuum cleaner has been designed to look nice, it is robust and has many functions; it is equipped with a double ventilation duct, an integrated dust bag, a three-level HEPA filtration system, and it can recover very fine dust.

The front is equipped with swivel wheels and the rear with large unidirectional wheels; easy to move; various accessories can be used for different functions; Efficient motors for both fans, higher suction, longer service life. It's the best material for cleaning in hotels, factories and other places.

2. THE PRODUCT

Technical data

Rated voltage	220-240V~
Rated frequency	50/60Hz
Rated power	1600,3600 W with max load of socket-outlet
Insulation class	Class I
Suction	≥ 18 kPa
Suction effectiveness	≥ 20%

List of contents

Name	Amount
Vacuum cleaner	1
Flexible hose	1
Telescopic tube	1
Floor brush	1
Round brush	1
Small tip	1
Manuals	1

Electrical diagram

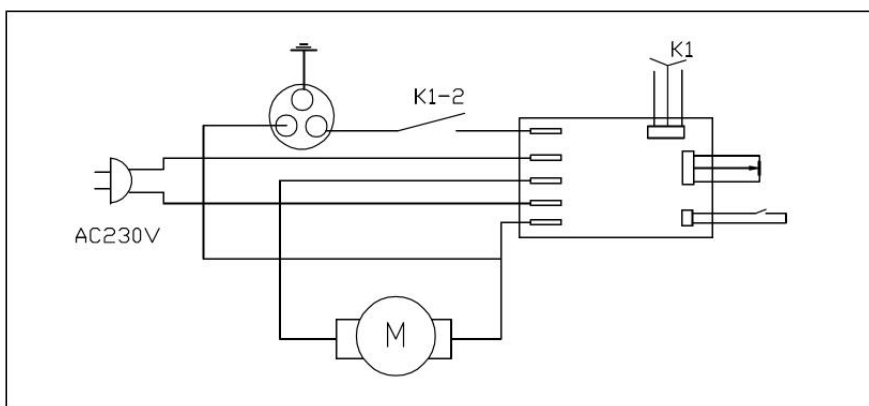

Main components

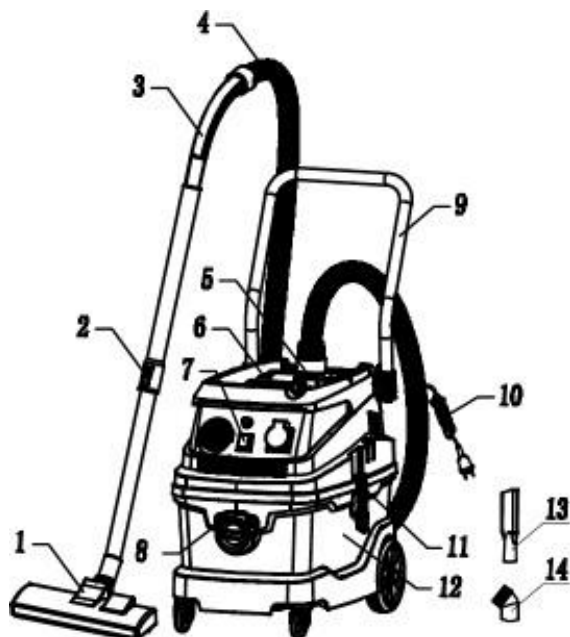

1	Floor brush	8	Front suction
2	Telescopic tube	9	Handle
3	Hose connector	10	Cable
4	Flexible hose	11	Fasteners
5	Top suction	12	Tank
6	Handle	13	Small tip
7	Switch	14	Round tip

Note:

The vacuum cleaner is equipped with a double suction structure including front and top suction, they can be used for different functions.

Top suction (Fig. A)

If the hose is connected to the top suction, you may need to install a plug on the front suction.





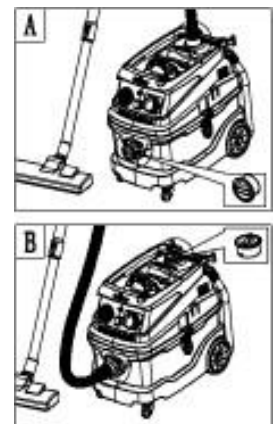



Use the front suction to suck water (Fig. B)

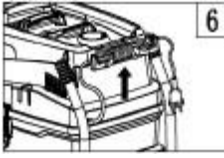
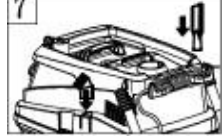



If the hose is connected to the front suction, you may need to install a plug on the top suction.

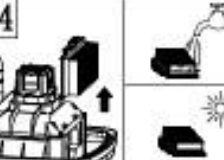

3. OPERATION

<p>1. On or Off (Fig. 1)</p> <p>(1). Switch on: After inserting the electrical plug into the socket, turn the switch to position 1, the vacuum cleaner starts.</p> <p>(2). To stop: Turn the switch to 0 position, the vacuum cleaner stops.</p>	
<p>2. Connect the hose to the vacuum cleaner (Fig. 2)</p> <p>Insertion: insert the connector into the suction mouth, and then turn it clockwise to lock it.</p> <p>Removal: turn the connector counter clockwise to disengage the hose.</p>	
<p>3. Connect the hose to the tube (Fig. 3)</p> <p>(1). Connect the hose to the tube, turn it clockwise to secure. (2). Hold both ends and turn counter clockwise.</p>	
<p>4. Connecting the floor brush (Fig. 4)</p> <p>(1). Connect the brush to the tube and then turn it clockwise to tighten.</p> <p>(2). Hold the end of the tube and the brush, then turn it counter clockwise to disconnect.</p>	
<p>5. Installation of the two swivel wheels (Fig. 5)</p> <p>(1). Remove the head and tank from the body of the vacuum cleaner (where the wheels are located)</p> <p>(2). Tilt the vacuum cleaner, insert the swivel wheels on the front in the holes on both sides.</p>	

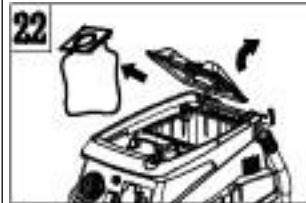
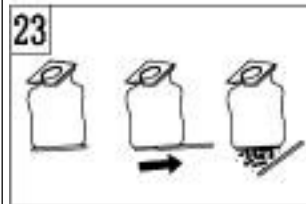
<p>6. Storage of the power cord (Fig. 6)</p> <p>(1). The cord supports are located on the back of the vacuum cleaner; when the unit is not in use, wind the cord on the supports.</p> <p>(2). To operate the machine, unwind the power cord.</p>	
<p>7. Storage of accessories (Fig. 7)</p> <p>The accessories can be stored with the two holes on the sides of the machine.</p>	
<p>8. Blowing function (Fig. 8)</p> <p>(1). Insert the tube into the blowing connection (2). Blowing connection</p>	
<p>9. Blowing reversal function (Fig. 9)</p> <p>(1). When the suction decreases, insert the hose head and press the button.</p> <p>(2). Repeat three to five times, the suction will increase.</p>	
<p>10. Mounting of the dust bag (Fig. 10) (1). Remove the transparent cover. (2). Install the dust bag and reassemble the unit.</p>	
<p>11. Replacement of the dust bag (Fig. 11)</p> <p>(1). Remove the transparent cover holding the dust bag. (2). Change the dust bag with the new.</p>	
<p>12. Separate the tank head (Fig. 12) (1). Open the 2 side fixings. (2). Take the handle in hand and lift the head.</p>	
<p>13. Replacement of the filter (Fig. 13)</p> <p>(1). Remove the cover, the filter is at the bottom, remove the filter.</p> <p>(2). Replace the old filter with a new one, then reassemble.</p>	
<p>14. Cleaning the filter (Fig. 14)</p> <p>(1). Remove the filter and wash it with clean water. (2). After cleaning, dry the filter for reuse.</p>	
<p>15. Cleaning the connectors (Fig. 15)</p> <p>(1). Remove the connectors from the cover and clean them with water.</p> <p>(2). Replace the connectors and secure them well.</p>	

<p>16. Adding water (Fig. 16)</p> <p>(1). Remove the head from the body of the vacuum cleaner, add water to the tank.</p> <p>(2). Take note of the "Water level", avoid adding too much water.</p>	
<p>17. Speed control operation (Fig. 17)</p> <p>(1). Speed control above the switch</p> <p>(2). Turn the speed control to the left, the suction decreases. Turn the speed control to the right, the suction increases.</p>	
<p>18. Synchronous operation with a power tool (Fig. 18)</p> <p>(1). Connect the suction hose with the dust absorption port of the power tool.</p> <p>(2). Connect the power tool plug into the synchronous socket of the vacuum cleaner.</p> <p>(3). Turn the switch to "-" position to be in standby mode. When the power tool is switched on, the vacuum cleaner switches on.</p>	
<ul style="list-style-type: none"> • Accessories instructions Floor brush Used for cleaning carpet, parquet, marble, tiles, etc. Big tip Used to clean wall corners, windows, etc. Large round brush Used for sofa edges, picture frames, etc. • Cleaning of the dust (Fig. 22) -> (Fig. 23) <p>(1). Remove the back cover with the dust bag of the tank of the vacuum cleaner.</p> <p>(2). Remove the bar at the bottom of the dust bag, remove the dust.</p> <p>(3). Place the clip back on the dust bag, attach it to the rear cover and place everything back into the tank.</p> <ul style="list-style-type: none"> • Cleaning of dirty water (Fig. 24) <p>(1). Place the vacuum cleaner next to a drain, remove the head of the vacuum cleaner.</p> <p>(2). Tilt the vacuum cleaner tank and drain the dirty water.</p> <p>(3). Clean the body with clean water, place the vacuum cleaner head back.</p>	  

4. MAINTENANCE

- To extend the life of the device, do not use it more than 20 minutes at a time.
- To extend the life of the device, clean the body, filter and dust bag after use.
- Wrap the power cord, store the accessories.
- Remove the dirty water after use to prevent rust or corrosion of the tank.
- Clean the surface of the vacuum cleaner with a dry cloth to avoid that water in vacuum cleaner causing a short-circuit or even fire.

5. TROUBLESHOOTING

Default	Possible reason	Handling method
Engine failure	<ol style="list-style-type: none"> 1. Check if the plug is properly wired 2. Check if the power outlet is connected 3. Check if the power switch is in the ON position 	<ol style="list-style-type: none"> 1. Place the plug back into the outlet 2. Ensure that the power outlet is turned on 3. Put the switch in the ON position
No suction	<ol style="list-style-type: none"> 1. Check if the brush, hose and telescopic tube for blockages 2. Check if the dust bag is full 3. Check if the filter is clogged 	<ol style="list-style-type: none"> 1. Unclog the blockages 2. Clean the dust bag 3. Clean the filter
Hot air outlet	<ol style="list-style-type: none"> 1. Check if the suction is normal 	<ol style="list-style-type: none"> 1. Hot air coming out of the vacuum cleaner is due
	<ol style="list-style-type: none"> 2. Check if the duration of use has exceeded 20 minutes 	<p>to the heat conduction of the motor. This is common, you can continue using it.</p> <ol style="list-style-type: none"> 2. Leave it in stand by for 20 minutes before using it again.

6. EXPLODED VIEW AND PARTS LIST

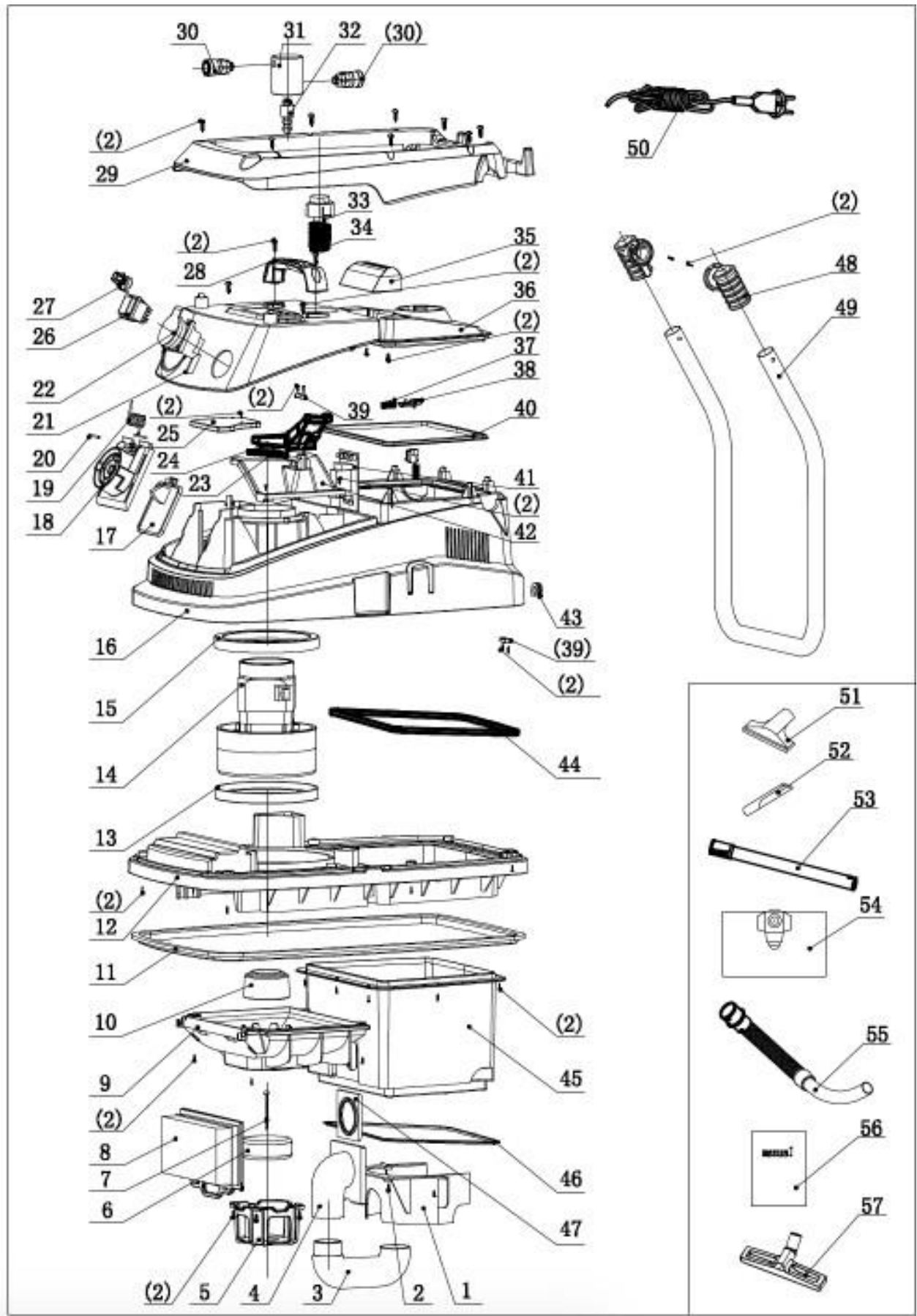

n.	Name	Amount	n.	Name	Amount
1	Protection against water	1	30	Pneumatic tool joint	no
2	Screw ST4 x 16	1	31	Air valve seat	no
3	Moulded blowing hose	1	32	Liquid level switch	no
4	Connection column	1	33	Reverse blowing button	no
5	Floating ball attachment	1	34	Blowing reversing spring	1
6	Floating ball	1	35	Rear cover handle	1
7	Screw ST4 x 70	1	36	Rear cover	1
8	Flat filter	1	37	Board spring	1
9	Flat filter attachment	1	38	Board fixing pin	1
10	Valve	1	39	Plate-pressing coating	1
11	Lower cover closure ring	1	40	Rear cover closure ring	1
12	Lower cover	1	41	Circuit board	1
13	Top motor closure ring	1	42	Motor top cover	1
14	Motor A30-1	1	43	Power cord blocking	1
15	Lower motor closure ring	1	44	Middle closure ring of the cover	1
16	Middle cover	1	45	Internal tank	1
17	Air outlet flap	1	46	Internal tank closure ring	1
18	Air outlet base	1	47	Connection column closure	1
19	Base air outlet spring	1	48	Handle attachment	1
20	Fixed axis base air outlet	1	49	Handle	1
21	Front cover	1	50	Power cord 3 x 1.5 mm ² , 4.50 m	1
22	Synchronizer	1	51	Small "T" brush ø32	
23	Closure ring of the reverse blowing panel	1	52	Small tip	
24	Reverse blowing panel	1	53	Telescopic tube in metal	1
25	Air duct cover	1	54	Dust bag	1
26	Switch (three-phase)	1	55	Hose ø 32, 2 m	1
27	Speed control	1	56	Manual	1
28	Handle	1	57	Brush ø 32 for dry and wet	1
29	Top cover	1			

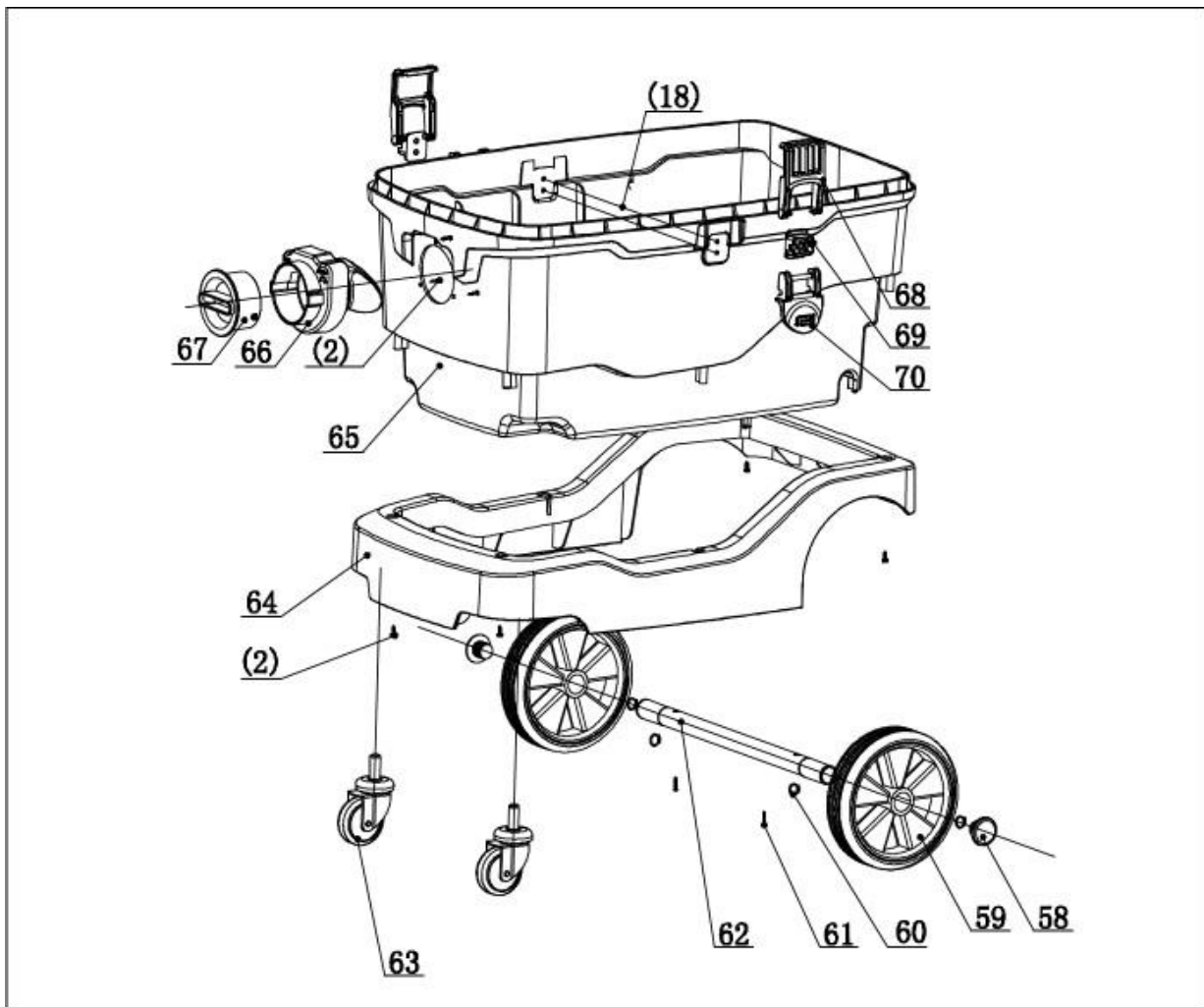

n.	Name	Amount	n.	Name	Amount
58	Blocking steel pipe	2	65	External tank	1
59	Rear wheel	2	66	Base air inlet	1
60	Snap Ring Ø19	2	67	Air inlet cover	1
61	Screw ST5 x 40	1	68	Plastic fastener	2
62	Rear wheel axle	1	69	Fastener plastic base	2
63	Front meta wheel Ø50	2	70	Plastic fastener joint	2
64	Lower base	1	71		

7. DISPOSAL

Correct Disposal of this product



This marking indicates that this product should not be disposed with other household wastes throughout the EU. Electric and electronic equipment can be hazardous for the environment and for human health since they contain hazardous substances. To prevent possible harm to the environment or human health from uncontrolled waste disposal, recycle it responsibly to promote the sustainable reuse of material resources. To return your used device, please use the return and collection systems or contact the retailer where the product was purchased. They can take this product for environmental safe recycling.

8. DECLARATION OF CONFORMITY



BUILDER SAS

ZI - 32 rue aristide Bergès - 31270 Cugnaux - France
Tel : +33 (0)5.34.502.502 Fax : +33 (0)5.34.502.503

States that the designated below machine :
WATER AND DUST VACUUM CLEANER
Model: FAP1630

S/N: 20240700636-20240700735

is in conformity with the essential requirements and other relevant provisions of the applicable European Directives, based on the application of European harmonized standards.
Any unauthorized modification of the apparatus voids this declaration.

Satisfies the requirement of the Council Directives:
EC- Low voltage directive 2014/35/EU
EC Directive of Electromagnetic Compatibility 2014/30/EU
Rohs Directive 2011/65/EU & (EU) 2015/863

and conforms with the norms:

EN 60335-1:2012+A11:2014+A13:2017+A1:2019+A2:2019+A14:2019+A15:2021
EN 60335-2-2:2010+A11:2012+A1:2013
EN 62233 : 2008
EN IEC55014-1:2021
EN IEC55014-2:2021
EN IEC 61000-3-2:2019+A1:2021
EN 61000-3-3:2013+A1:2019+A2:2021

Done at Cugnaux : 29/05/2024

Philippe MARIE/PDG

9. WARRANTY

The manufacturer guarantees the product against defects in material and workmanship for a period of 2 years from the date of the original purchase. It can be extended by one year if the user subscribes to website of myswap. The warranty only applies if the product is for household use. The warranty does not cover breakdowns due to normal wear and tear.

The manufacturer agrees to replace parts identified as defective by the designated distributor. The manufacturer does not accept responsibility for the replacement of the machine, in whole or in part, and/or ensuing damage.

The warranty does not cover breakdowns due to:

- insufficient maintenance.
- abnormal assembly, adjustment or operations of the product.
- parts subject to normal wear and tear.

The warranty does not extend to:

- shipping and packaging costs.
- using the tool for a purpose other than that for which it was designed.
- the use and maintenance of the machine done in a manner not described in the user manual.

Due to our policy of continuous product improvement, we reserve the right to alter or change specifications without notice. Consequently, the product may be different from the information contained therein, but a modification will be undertaken without notice if it is recognized as an improvement of the preceding characteristic.

READ THE MANUAL CAREFULLY BEFORE USING THE MACHINE.

When ordering spare parts, please indicate the part number or code, you can find this in the spare parts list in this manual. Keep the purchase receipt; without it, the warranty is invalid. To help you with your product, we invite you to contact us by phone or via our website:

+33 (0)9.70.75.30.30

<https://services.swap-europe.com/contact>

You must create a "ticket" via the web platform.

- Register or create your account.
- Indicate the reference of the tool.
- Choose the subject of your request.
- Describe your problem.

Attach these files: invoice or sales receipt, photo of the identification plate (serial number), photo of the part you need (for example: pins on the transformer plug which are broken).



10. PRODUCT FAILURE

WHAT TO DO IF MY MACHINE BREAKS DOWN?

If you bought your product in a store:

- Make sure that your machine is complete with all accessories supplied, and clean! If this is not the case, the repairer will refuse the machine.
- Go to the store with the complete machine and with the receipt or invoice.

If you bought your product on a website:

- Make sure that your machine is complete with all accessories supplied, and clean! If this is not the case, the repairer will refuse the machine.
- Create a SWAP-Europe service ticket on the site: <https://services.swap-europe.com> When making the request on SWAP-Europe, you must attach the invoice and the photo of the nameplate (serial number).

Contact the repair station to make sure it is available before dropping off the machine.

Go to the repair station with the complete machine packed, accompanied by the purchase invoice and the station support sheet downloadable after the service request is completed on the SWAP-Europe site

Please keep your original packaging to allow for after-sales service returns or pack your machine with a similar cardboard box of the same dimensions.

For any question concerning our after-sales service you can make a request on our website <https://services.swap-europe.com>

Our hotline remains available at +33 (9) 70 75 30 30.



11. WARRANTY EXCLUSIONS

THE WARRANTY DOES NOT COVER:

- Start-up and setting up of the product.
- Damage resulting from normal wear and tear of the product.
- Damage resulting from improper use of the product.
- Damage resulting from assembly or start-up not in accordance with the user manual.
- Periodic and standard maintenance events.
- Actions of modification and dismantling that directly void the warranty.
- Products whose original authentication marking (brand, serial number) has been degraded, altered or withdrawn.
- Replacement of consumables.
- The use of non-original parts.
- Breakage of parts following impacts or projections.
- Accessories breakdowns.
- Defects and their consequences linked to any external cause.
- Loss of components and loss due to insufficient screwing.
- Cutting components and any damage related to the loosening of parts.
- Overload or overheating.
- Poor power supply quality: faulty voltage, voltage error, etc.
- Damages resulting from the deprivation of enjoyment of the product during the time necessary for repairs and more generally the costs related to the immobilization of the product.
- The costs of a second opinion established by a third party following an estimate by a SWAP-Europe repair station
- The use of a product which would show a defect or a breakage which was not the subject of an immediate report and/or repair with the services of SWAP-Europe.
- Deterioration linked to transport and storage*.

* In accordance with transport legislation, damage related to transport must be declared to carriers within 48 hours maximum after observation by registered letter with acknowledgement of receipt. This document is a supplement to your notice, a non-exhaustive list.

Attention: all orders must be checked in the presence of the delivery person. In case of refusal by the delivery person, it you must simply refuse the delivery and notify your refusal.

Reminder: the reserves do not exclude the notification by registered letter with acknowledgement within 72 hours.

Information:

Thermal devices must be wintered each season (service available on the SWAP-Europe site). Batteries must be charged before being stored.

FEIDER



BUILDER SAS

32 rue Aristide Bergès - Z.I. du Casque - 31270 Cugnaux - France

Made in PRC